

# BUH50G

## SWITCHMODE™ NPN Silicon Planar Power Transistor

The BUH50G has an application specific state-of-art die designed for use in 50 Watts HALOGEN electronic transformers and SWITCHMODE applications.

### Features

- Improved Efficiency Due to Low Base Drive Requirements:  
High and Flat DC Current Gain  $h_{FE}$   
Fast Switching
- ON Semiconductor Six Sigma Philosophy Provides Tight and Reproducible Parametric Distributions
- Specified Dynamic Saturation Data
- Full Characterization at 125°C
- These Devices are Pb-Free and are RoHS Compliant\*

### MAXIMUM RATINGS

Rating	Symbol	Value	Unit
Collector-Emitter Sustaining Voltage	$V_{CEO}$	500	Vdc
Collector-Base Breakdown Voltage	$V_{CBO}$	800	Vdc
Collector-Emitter Breakdown Voltage	$V_{CES}$	800	Vdc
Emitter-Base Voltage	$V_{EBO}$	9	Vdc
Collector Current – Continuous – Peak (Note 1)	$I_C$ $I_{CM}$	4 8	Adc
Base Current – Continuous – Peak (Note 1)	$I_B$ $I_{BM}$	2 4	Adc
Total Device Dissipation @ $T_C = 25^\circ\text{C}$ Derate above 25°C	$P_D$	50 0.4	W W/°C
Operating and Storage Temperature	$T_J, T_{stg}$	-65 to 150	°C

### THERMAL CHARACTERISTICS

Characteristics	Symbol	Max	Unit
Thermal Resistance, Junction-to-Case	$R_{\theta JC}$	2.5	°C/W
Thermal Resistance, Junction-to-Ambient	$R_{\theta JA}$	62.5	°C/W
Maximum Lead Temperature for Soldering Purposes 1/8" from Case for 5 Seconds	$T_L$	260	°C

Stresses exceeding Maximum Ratings may damage the device. Maximum Ratings are stress ratings only. Functional operation above the Recommended Operating Conditions is not implied. Extended exposure to stresses above the Recommended Operating Conditions may affect device reliability.

1. Pulse Test: Pulse Width = 5 ms, Duty Cycle  $\leq 10\%$ .

\*For additional information on our Pb-Free strategy and soldering details, please download the ON Semiconductor Soldering and Mounting Techniques Reference Manual, SOLDERRM/D.



ON Semiconductor®

<http://onsemi.com>

**POWER TRANSISTOR  
4 AMPERES  
800 VOLTS, 50 WATTS**

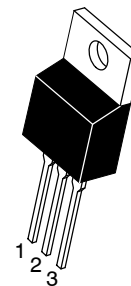
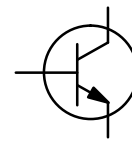

TO-220AB  
CASE 221A-09  
STYLE 1

### MARKING DIAGRAM



BUH50 = Device Code  
A = Assembly Location  
Y = Year  
WW = Work Week  
G = Pb-Free Package

### ORDERING INFORMATION

Device	Package	Shipping
BUH50G	TO-220 (Pb-Free)	50 Units / Rail

# BUH50G

## ELECTRICAL CHARACTERISTICS (T<sub>C</sub> = 25°C unless otherwise noted)

Characteristic	Symbol	Min	Typ	Max	Unit
----------------	--------	-----	-----	-----	------

### OFF CHARACTERISTICS

Collector-Emitter Sustaining Voltage (I <sub>C</sub> = 100 mA, L = 25 mH)	V <sub>CEO(sus)</sub>	500			Vdc
Collector Cutoff Current (V <sub>CE</sub> = Rated V <sub>CEO</sub> , I <sub>B</sub> = 0)	I <sub>CEO</sub>			100	μAdc
Collector Cutoff Current @ T <sub>C</sub> = 25°C (V <sub>CE</sub> = Rated V <sub>CES</sub> , V <sub>EB</sub> = 0) @ T <sub>C</sub> = 125°C	I <sub>CES</sub>			100 1000	μAdc
Emitter-Cutoff Current (V <sub>EB</sub> = 9 Vdc, I <sub>C</sub> = 0)	I <sub>EBO</sub>			100	μAdc

### ON CHARACTERISTICS

Base-Emitter Saturation Voltage (I <sub>C</sub> = 1 Adc, I <sub>B</sub> = 0.33 Adc) (I <sub>C</sub> = 2 Adc, I <sub>B</sub> = 0.66 Adc) 25°C (I <sub>C</sub> = 2 Adc, I <sub>B</sub> = 0.66 Adc) 100°C	V <sub>BE(sat)</sub>		0.86 0.94 0.85	1.2 1.6 1.5	Vdc
Collector-Emitter Saturation Voltage (I <sub>C</sub> = 1 Adc, I <sub>B</sub> = 0.33 Adc) (I <sub>C</sub> = 2 Adc, I <sub>B</sub> = 0.66 Adc) (I <sub>C</sub> = 3 Adc, I <sub>B</sub> = 1 Adc)	V <sub>CE(sat)</sub>	@ T <sub>C</sub> = 25°C @ T <sub>C</sub> = 25°C @ T <sub>C</sub> = 125°C @ T <sub>C</sub> = 25°C	0.2 0.32 0.29 0.5	0.5 0.6 0.7 1	Vdc
DC Current Gain (I <sub>C</sub> = 1 Adc, V <sub>CE</sub> = 5 Vdc) (I <sub>C</sub> = 2 Adc, V <sub>CE</sub> = 5 Vdc)	h <sub>FE</sub>	@ T <sub>C</sub> = 25°C @ T <sub>C</sub> = 25°C	7 5	13 10	- -

### DYNAMIC CHARACTERISTICS

Current Gain Bandwidth (I <sub>C</sub> = 0.5 Adc, V <sub>CE</sub> = 10 Vdc, f = 1 MHz)	f <sub>T</sub>	4			MHz
Output Capacitance (V <sub>CB</sub> = 10 Vdc, I <sub>E</sub> = 0, f = 1 MHz)	C <sub>ob</sub>		50	100	pF
Input Capacitance (V <sub>EB</sub> = 8 Vdc)	C <sub>ib</sub>		850	1200	pF

### DYNAMIC SATURATION VOLTAGE

Dynamic Saturation Voltage: Determined 1 μs and 3 μs respectively after rising I <sub>B1</sub> reaches 90% of final I <sub>B1</sub>	I <sub>C</sub> = 1 A I <sub>B1</sub> = 0.33 A V <sub>CC</sub> = 300 V	@ 1 μs	@ T <sub>C</sub> = 25°C @ T <sub>C</sub> = 125°C	V <sub>CE(dsat)</sub>	1.75 5		V
		@ 3 μs	@ T <sub>C</sub> = 25°C @ T <sub>C</sub> = 125°C		0.3 0.5		V
	I <sub>C</sub> = 2 A I <sub>B1</sub> = 0.66 A V <sub>CC</sub> = 300 V	@ 1 μs	@ T <sub>C</sub> = 25°C @ T <sub>C</sub> = 125°C	6 14		V	
		@ 3 μs	@ T <sub>C</sub> = 25°C @ T <sub>C</sub> = 125°C	0.75 4		V	

### SWITCHING CHARACTERISTICS: Resistive Load (D.C. ≤ 10%, Pulse Width = 20 μs)

Turn-on Time	I <sub>C</sub> = 2 Adc, I <sub>B1</sub> = 0.4 Adc I <sub>B2</sub> = 0.4 Adc V <sub>CC</sub> = 125 Vdc	@ T <sub>C</sub> = 25°C	t <sub>on</sub>	95	250	ns
Turn-off Time		@ T <sub>C</sub> = 25°C	t <sub>off</sub>	2.5	3.5	μs
Turn-on Time	I <sub>C</sub> = 2 Adc, I <sub>B1</sub> = 0.4 Adc I <sub>B2</sub> = 1 Adc V <sub>CC</sub> = 125 Vdc	@ T <sub>C</sub> = 25°C	t <sub>on</sub>	110	250	ns
Turn-off Time		@ T <sub>C</sub> = 25°C	t <sub>off</sub>	0.95	2	μs
Turn-on Time	I <sub>C</sub> = 1 Adc, I <sub>B1</sub> = 0.3 Adc I <sub>B2</sub> = 0.3 Adc V <sub>CC</sub> = 125 Vdc	@ T <sub>C</sub> = 25°C	t <sub>on</sub>	100	200	ns
Turn-off Time		@ T <sub>C</sub> = 25°C	t <sub>off</sub>	2.9	3.5	μs

### SWITCHING CHARACTERISTICS: Inductive Load (V<sub>clamp</sub> = 300 V, V<sub>CC</sub> = 15 V, L = 200 μH)

Fall Time	I <sub>C</sub> = 2 Adc I <sub>B1</sub> = 0.4 Adc I <sub>B2</sub> = 1 Adc	@ T <sub>C</sub> = 25°C @ T <sub>C</sub> = 125°C	t <sub>f</sub>	80 95	150	ns
Storage Time		@ T <sub>C</sub> = 25°C @ T <sub>C</sub> = 125°C	t <sub>s</sub>	1.2 1.7	2.5	μs
Crossover Time		@ T <sub>C</sub> = 25°C @ T <sub>C</sub> = 125°C	t <sub>c</sub>	150 180	300	ns
Fall Time	I <sub>C</sub> = 2 Adc I <sub>B1</sub> = 0.66 Adc I <sub>B2</sub> = 1 Adc	@ T <sub>C</sub> = 25°C @ T <sub>C</sub> = 125°C	t <sub>f</sub>	90 100	150	ns
Storage Time		@ T <sub>C</sub> = 25°C @ T <sub>C</sub> = 125°C	t <sub>s</sub>	1.7 2.5	2.75	μs
Crossover Time		@ T <sub>C</sub> = 25°C @ T <sub>C</sub> = 125°C	t <sub>c</sub>	190 220	350	ns

TYPICAL STATIC CHARACTERISTICS

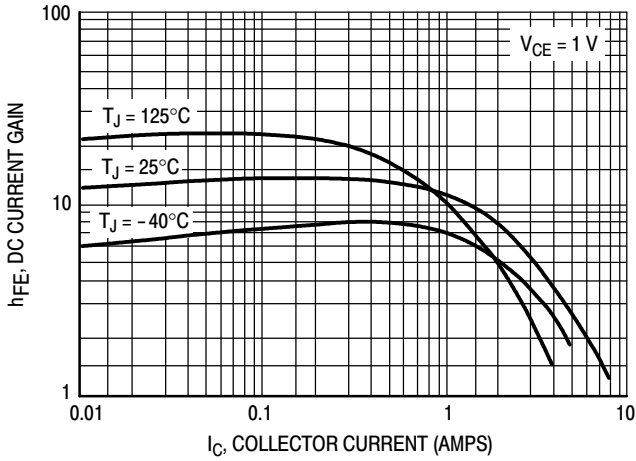

Figure 1. DC Current Gain @ 1 Volt

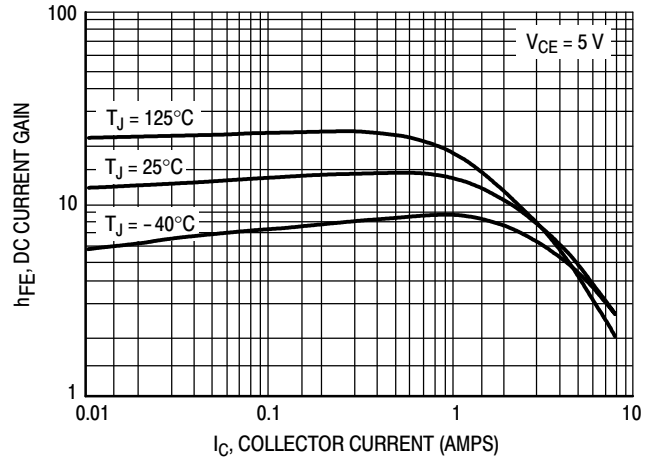

Figure 2. DC Current Gain @ 5 Volt

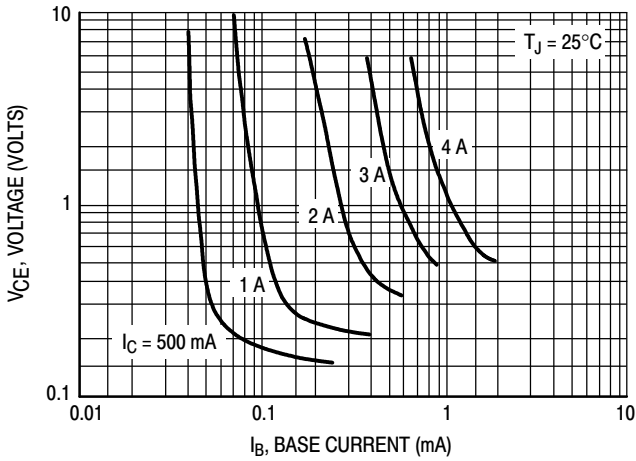

Figure 3. Collector Saturation Region

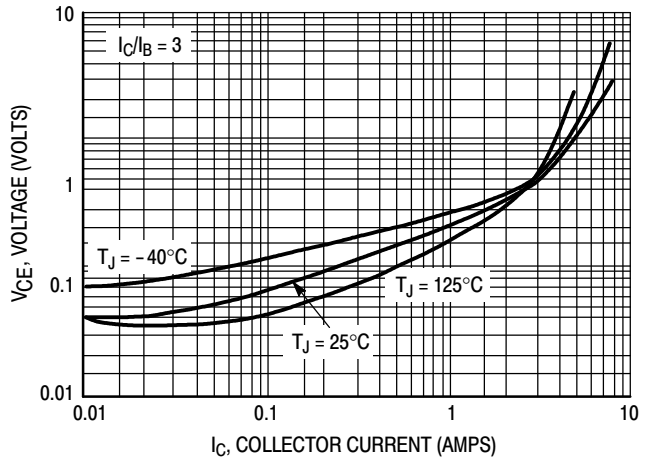

Figure 4. Collector-Emmitter Saturation Voltage

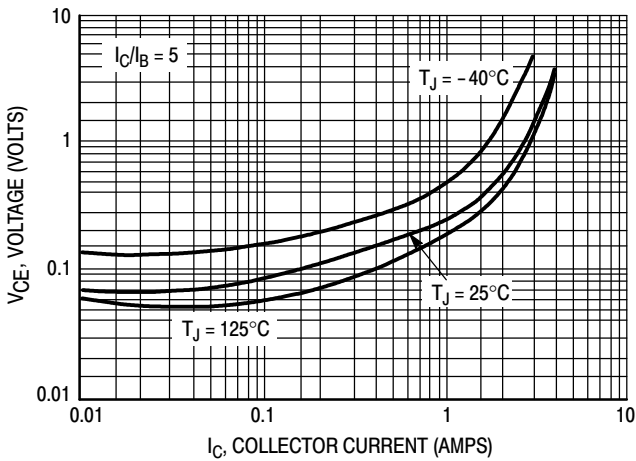

Figure 5. Collector-Emmitter Saturation Voltage

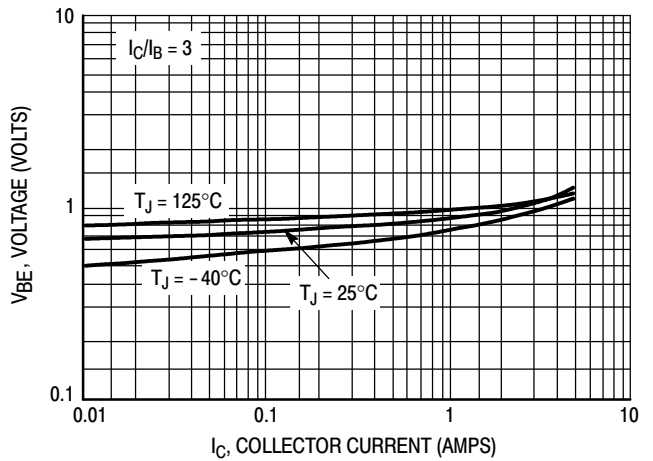

Figure 6. Base-Emmitter Saturation Region

TYPICAL STATIC CHARACTERISTICS

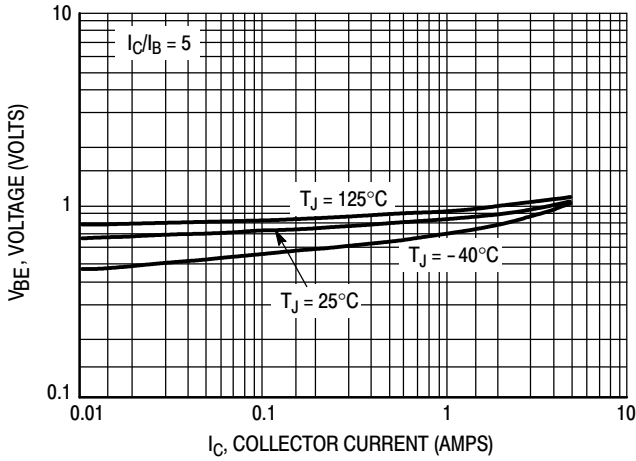

Figure 7. Base-Emitter Saturation Region

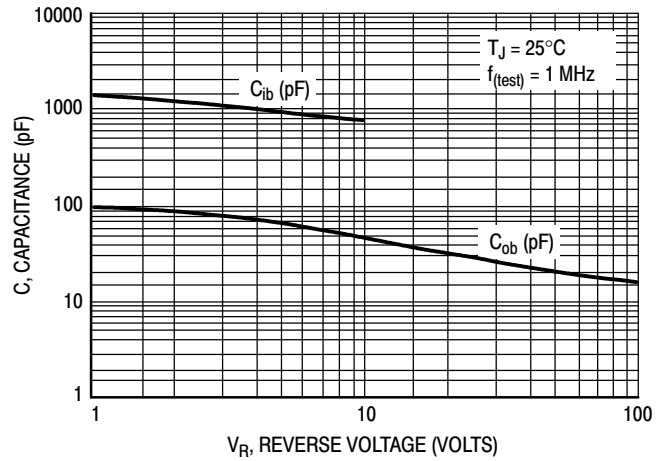

Figure 8. Capacitance

TYPICAL SWITCHING CHARACTERISTICS

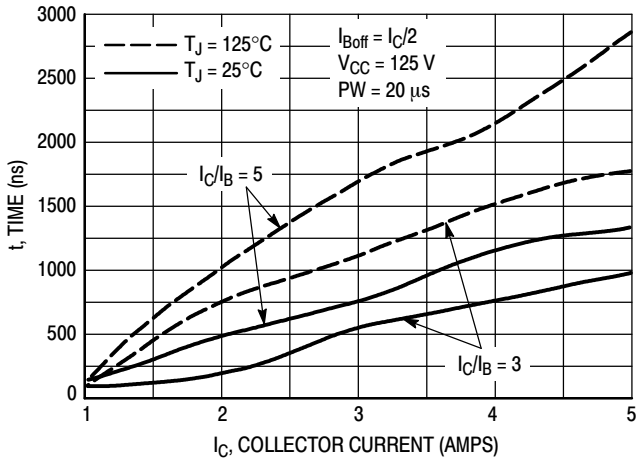

Figure 9. Resistive Switching,  $t_{on}$

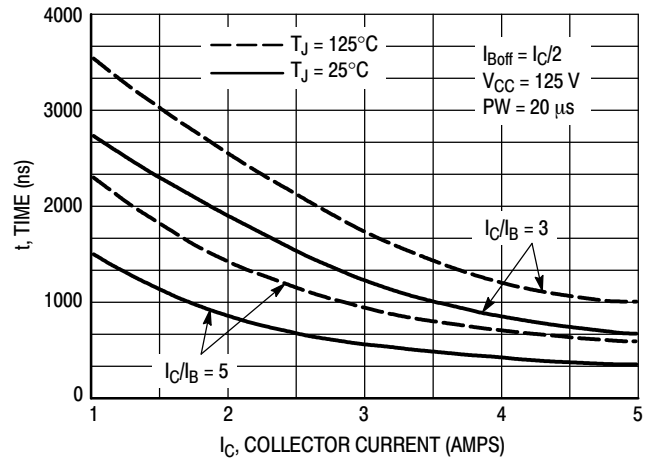

Figure 10. Resistive Switch Time,  $t_{off}$

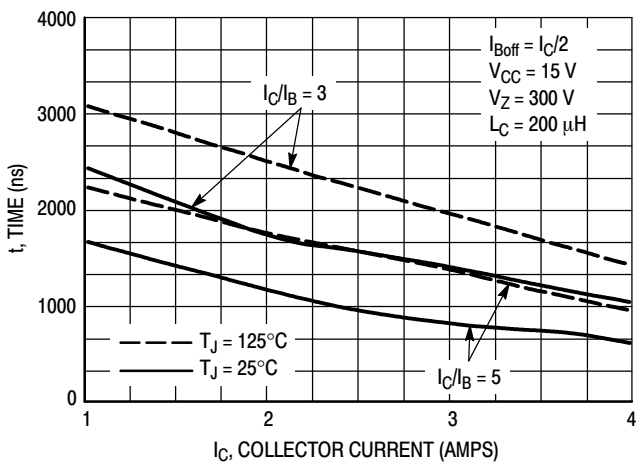

Figure 11. Inductive Storage Time,  $t_{si}$

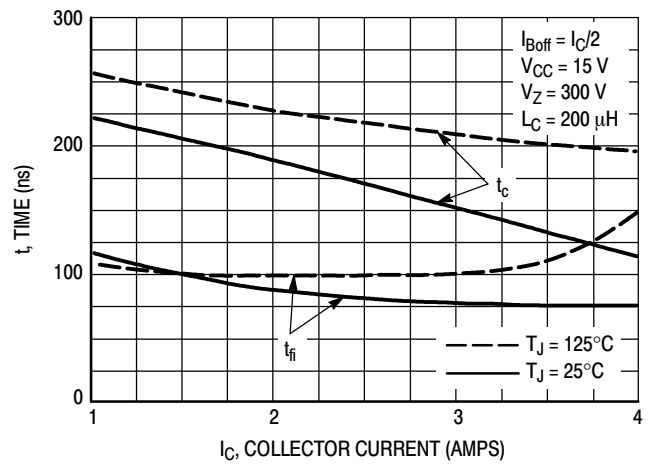

Figure 12. Inductive Storage Time,  $t_c$  &  $t_{fi}$  @  $I_C/I_B = 3$

# BUH50G

## TYPICAL CHARACTERISTICS

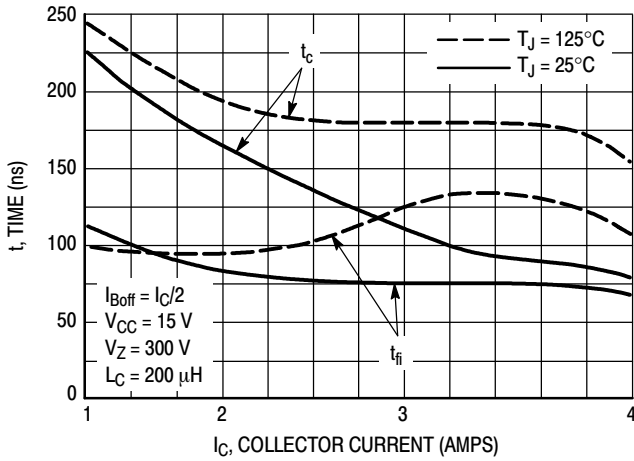

Figure 13. Inductive Switching,  $t_c$  &  $t_{fi}$  @  $I_C/I_B = 5$

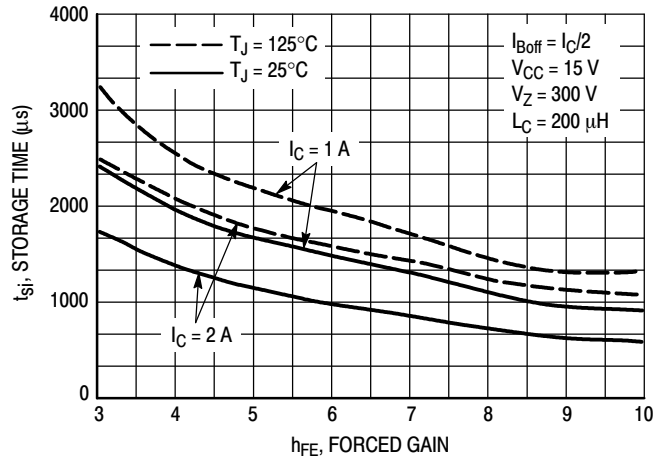

Figure 14. Inductive Storage Time

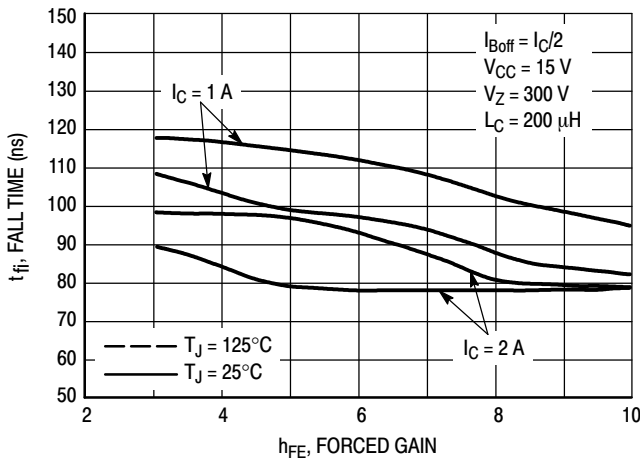

Figure 15. Inductive Fall Time

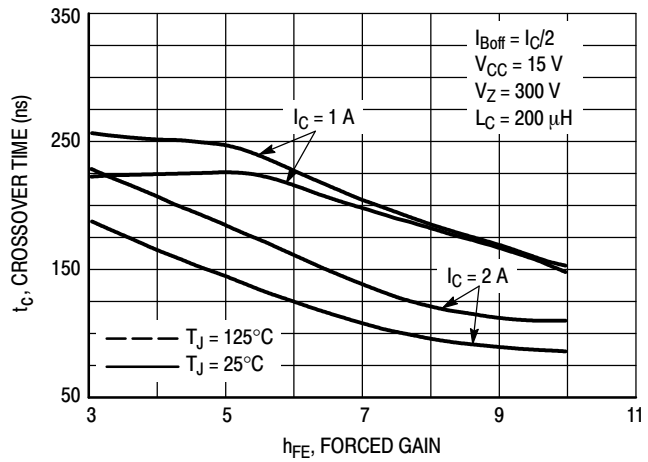

Figure 16. Inductive Crossover Time

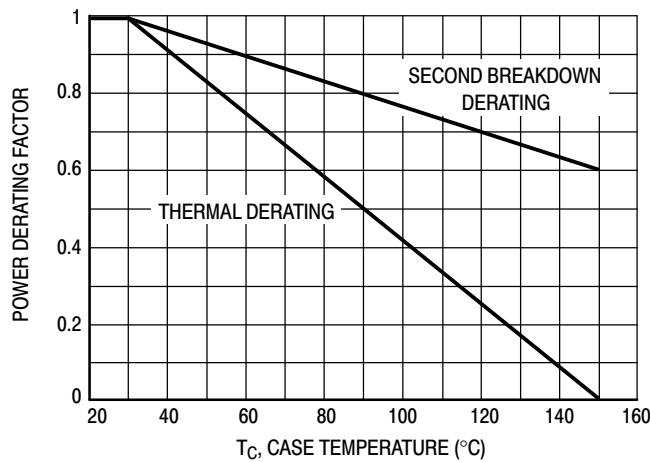

Figure 17. Forward Power Derating

# BUH50G

There are two limitations on the power handling ability of a transistor: average junction temperature and second breakdown. Safe operating area curves indicate  $I_C-V_{CE}$  limits of the transistor that must be observed for reliable operation; i.e., the transistor must not be subjected to greater dissipation than the curves indicate. The data of Figure 20 is based on  $T_C = 25^\circ\text{C}$ ;  $T_{J(pk)}$  is variable depending on power level. Second breakdown pulse limits are valid for duty cycles to 10% but must be derated when  $T_C > 25^\circ\text{C}$ . Second breakdown limitations do not derate the same as thermal limitations. Allowable current at the voltages shown on

Figure 20 may be found at any case temperature by using the appropriate curve on Figure 17.

$T_{J(pk)}$  may be calculated from the data in Figure 22. At any case temperatures, thermal limitations will reduce the power that can be handled to values less than the limitations imposed by second breakdown. For inductive loads, high voltage and current must be sustained simultaneously during turn-off with the base to emitter junction reverse biased. The safe level is specified as a reverse biased safe operating area (Figure 21). This rating is verified under clamped conditions so that the device is never subjected to an avalanche mode.

## TYPICAL CHARACTERISTICS

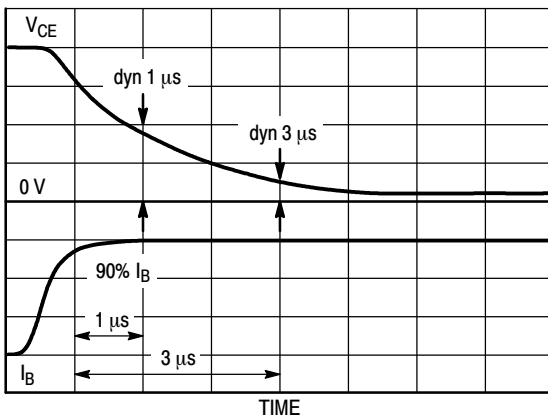

Figure 18. Dynamic Saturation Voltage

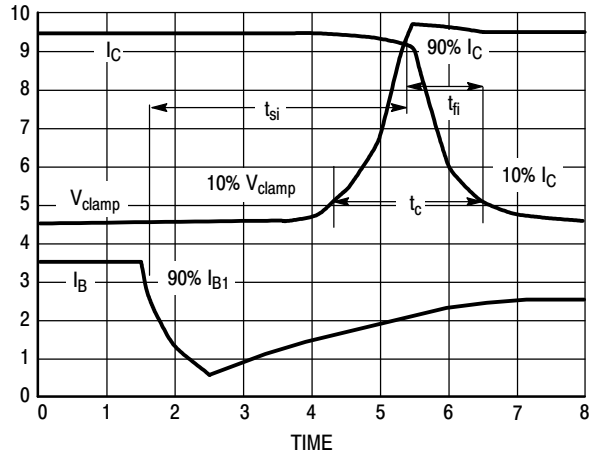

Figure 19. Inductive Switching Measurements

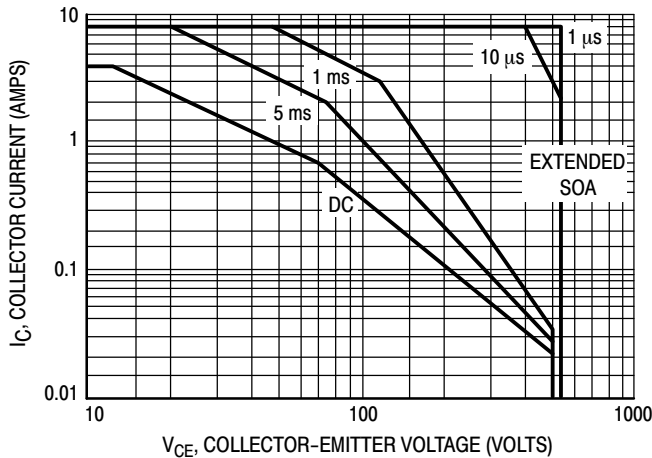

Figure 20. Forward Bias Safe Operating Area

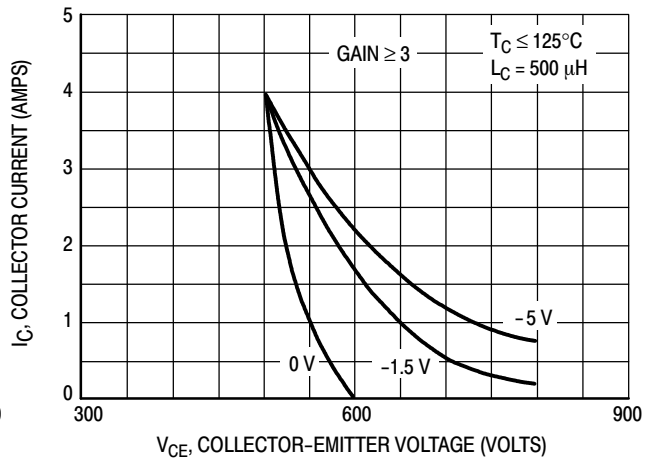
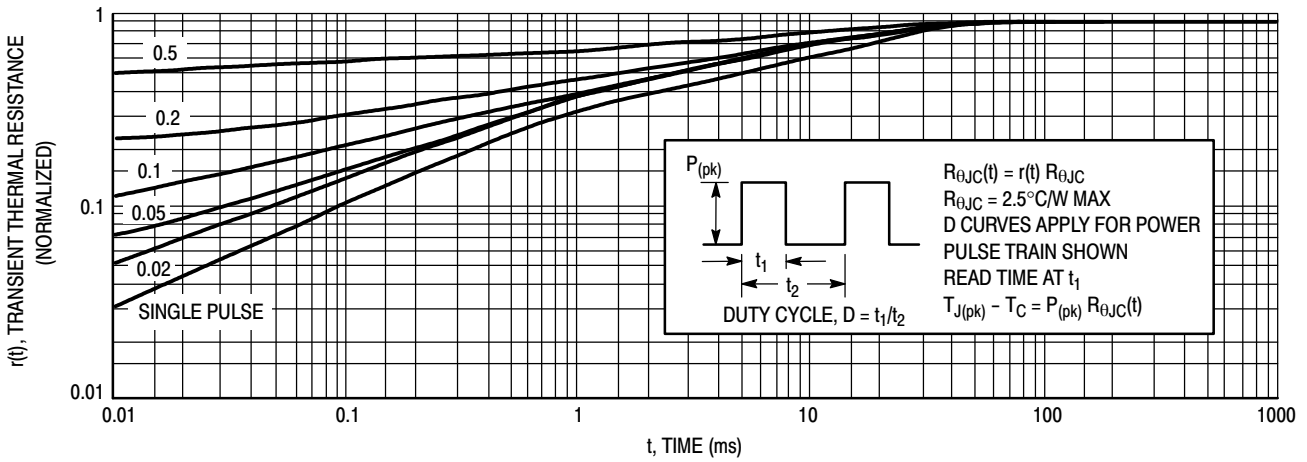
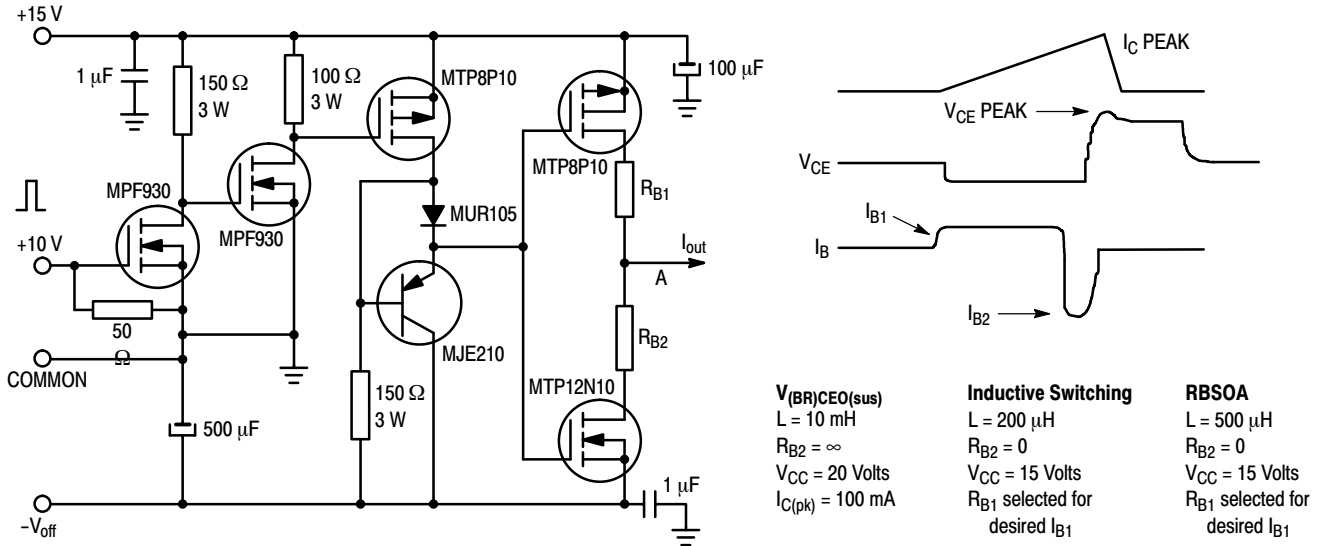

Figure 21. Reverse Bias Safe Operating Area

# BUH50G

## TYPICAL CHARACTERISTICS

Table 1. Inductive Load Switching Drive Circuit



# BUH50G

## PACKAGE DIMENSIONS

TO-220AB  
CASE 221A-09  
ISSUE AF

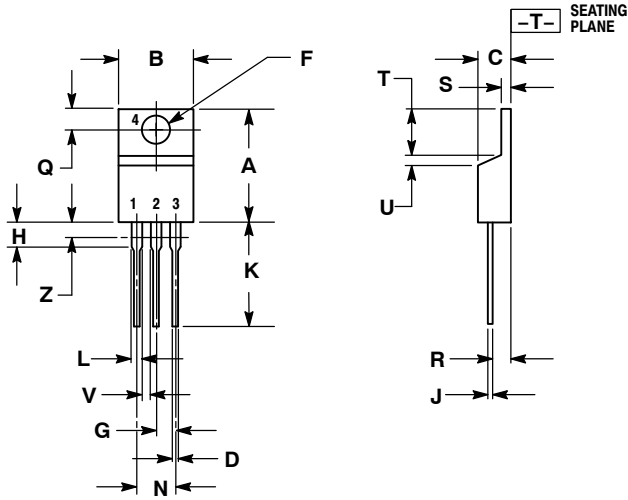

NOTES:

1. DIMENSIONING AND TOLERANCING PER ANSI Y14.5M, 1982.
2. CONTROLLING DIMENSION: INCH.
3. DIMENSION Z DEFINES A ZONE WHERE ALL BODY AND LEAD IRREGULARITIES ARE ALLOWED.

DIM	INCHES		MILLIMETERS	
	MIN	MAX	MIN	MAX
A	0.570	0.620	14.48	15.75
B	0.380	0.405	9.66	10.28
C	0.160	0.190	4.07	4.82
D	0.025	0.035	0.64	0.88
F	0.142	0.161	3.61	4.09
G	0.095	0.105	2.42	2.66
H	0.110	0.155	2.80	3.93
J	0.014	0.025	0.36	0.64
K	0.500	0.562	12.70	14.27
L	0.045	0.060	1.15	1.52
N	0.190	0.210	4.83	5.33
Q	0.100	0.120	2.54	3.04
R	0.080	0.110	2.04	2.79
S	0.045	0.055	1.15	1.39
T	0.235	0.255	5.97	6.47
U	0.000	0.050	0.00	1.27
V	0.045	---	1.15	---
Z	---	0.080	---	2.04

STYLE 1:

1. BASE
2. COLLECTOR
3. EMITTER
4. COLLECTOR

SWITCHMODE is a trademark of Semiconductor Components Industries, LLC.

ON Semiconductor and are registered trademarks of Semiconductor Components Industries, LLC (SCILLC). SCILLC reserves the right to make changes without further notice to any products herein. SCILLC makes no warranty, representation or guarantee regarding the suitability of its products for any particular purpose, nor does SCILLC assume any liability arising out of the application or use of any product or circuit, and specifically disclaims any and all liability, including without limitation special, consequential or incidental damages. "Typical" parameters which may be provided in SCILLC data sheets and/or specifications can and do vary in different applications and actual performance may vary over time. All operating parameters, including "Typicals" must be validated for each customer application by customer's technical experts. SCILLC does not convey any license under its patent rights nor the rights of others. SCILLC products are not designed, intended, or authorized for use as components in systems intended for surgical implant into the body, or other applications intended to support or sustain life, or for any other application in which the failure of the SCILLC product could create a situation where personal injury or death may occur. Should Buyer purchase or use SCILLC products for any such unintended or unauthorized application, Buyer shall indemnify and hold SCILLC and its officers, employees, subsidiaries, affiliates, and distributors harmless against all claims, costs, damages, and expenses, and reasonable attorney fees arising out of, directly or indirectly, any claim of personal injury or death associated with such unintended or unauthorized use, even if such claim alleges that SCILLC was negligent regarding the design or manufacture of the part. SCILLC is an Equal Opportunity/Affirmative Action Employer. This literature is subject to all applicable copyright laws and is not for resale in any manner.

### PUBLICATION ORDERING INFORMATION

**LITERATURE FULFILLMENT:**

Literature Distribution Center for ON Semiconductor  
P.O. Box 5163, Denver, Colorado 80217 USA  
Phone: 303-675-2175 or 800-344-3860 Toll Free USA/Canada  
Fax: 303-675-2176 or 800-344-3867 Toll Free USA/Canada  
Email: orderlit@onsemi.com

**N. American Technical Support:** 800-282-9855 Toll Free  
USA/Canada  
**Europe, Middle East and Africa Technical Support:**  
Phone: 421 33 790 2910  
**Japan Customer Focus Center**  
Phone: 81-3-5773-3850

**ON Semiconductor Website:** [www.onsemi.com](http://www.onsemi.com)

**Order Literature:** <http://www.onsemi.com/orderlit>

For additional information, please contact your local Sales Representative